

MOUNTING BOARD
1 1/2" x 7 1/2" x 1 1/8"
HARDWOOD.

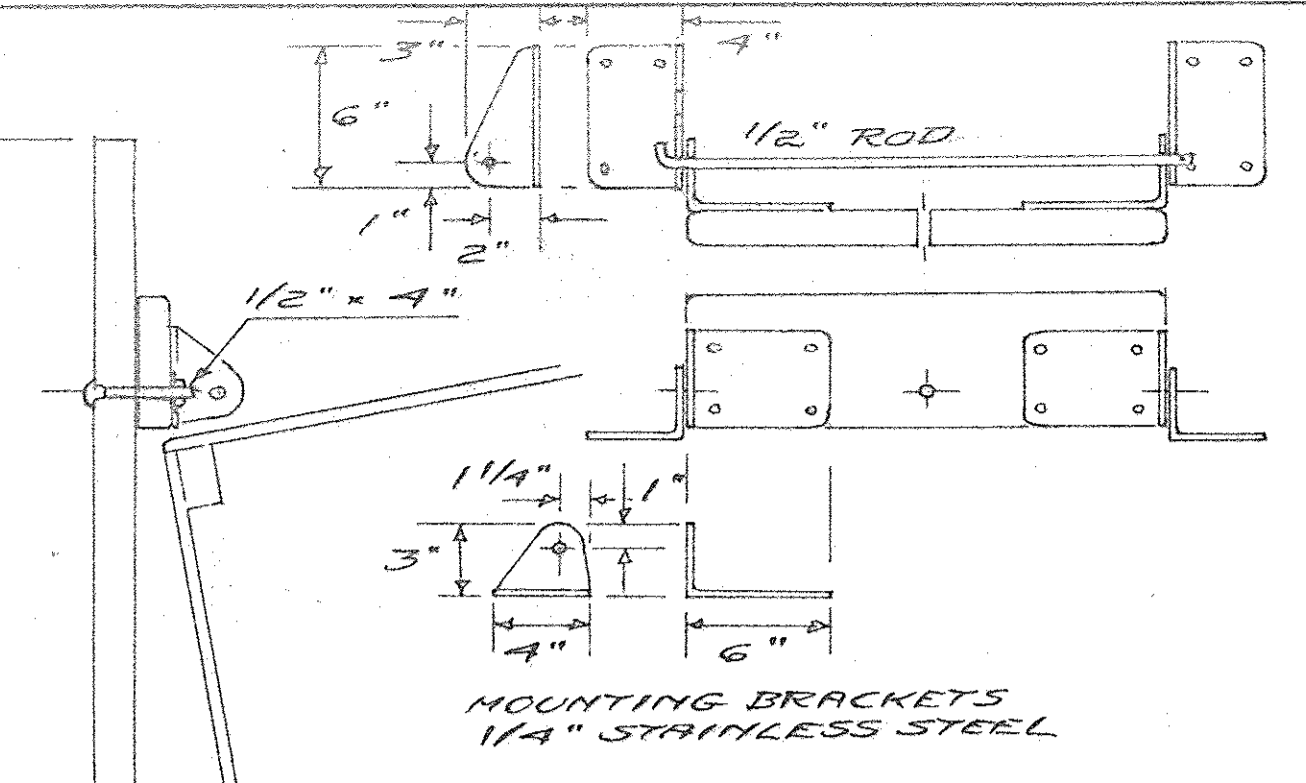

LEEBOARDS & MOUNTS
@ 1 1/2" = 1' 0"

1 1/2" PENDANT

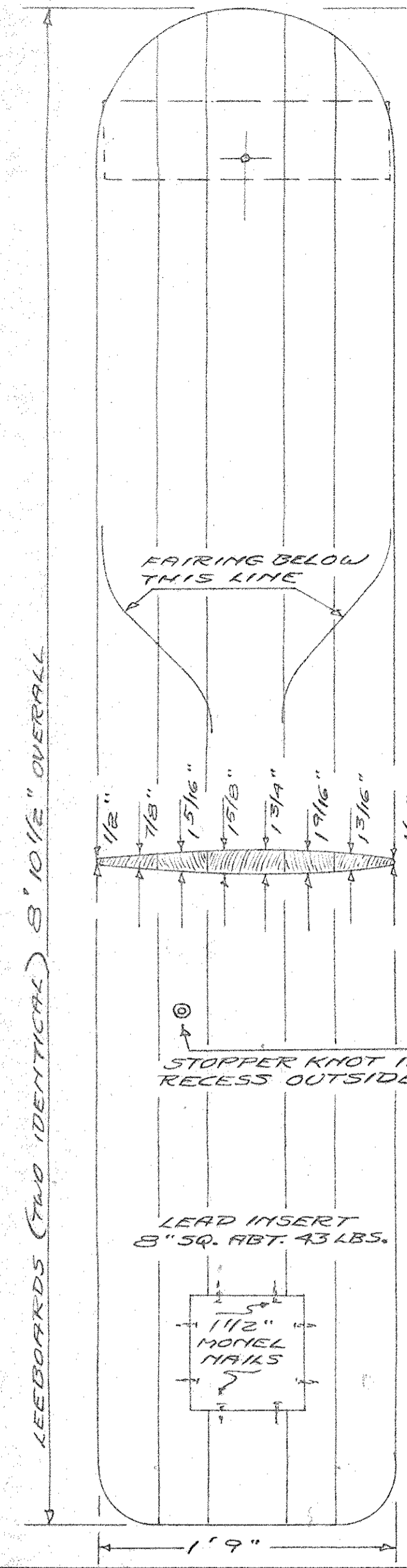
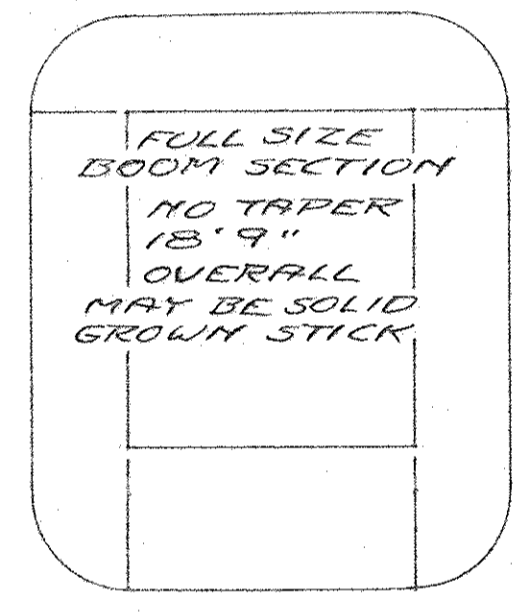

add peak halyard to center of ~~rod~~ while hoisting and lowering; slack when set.

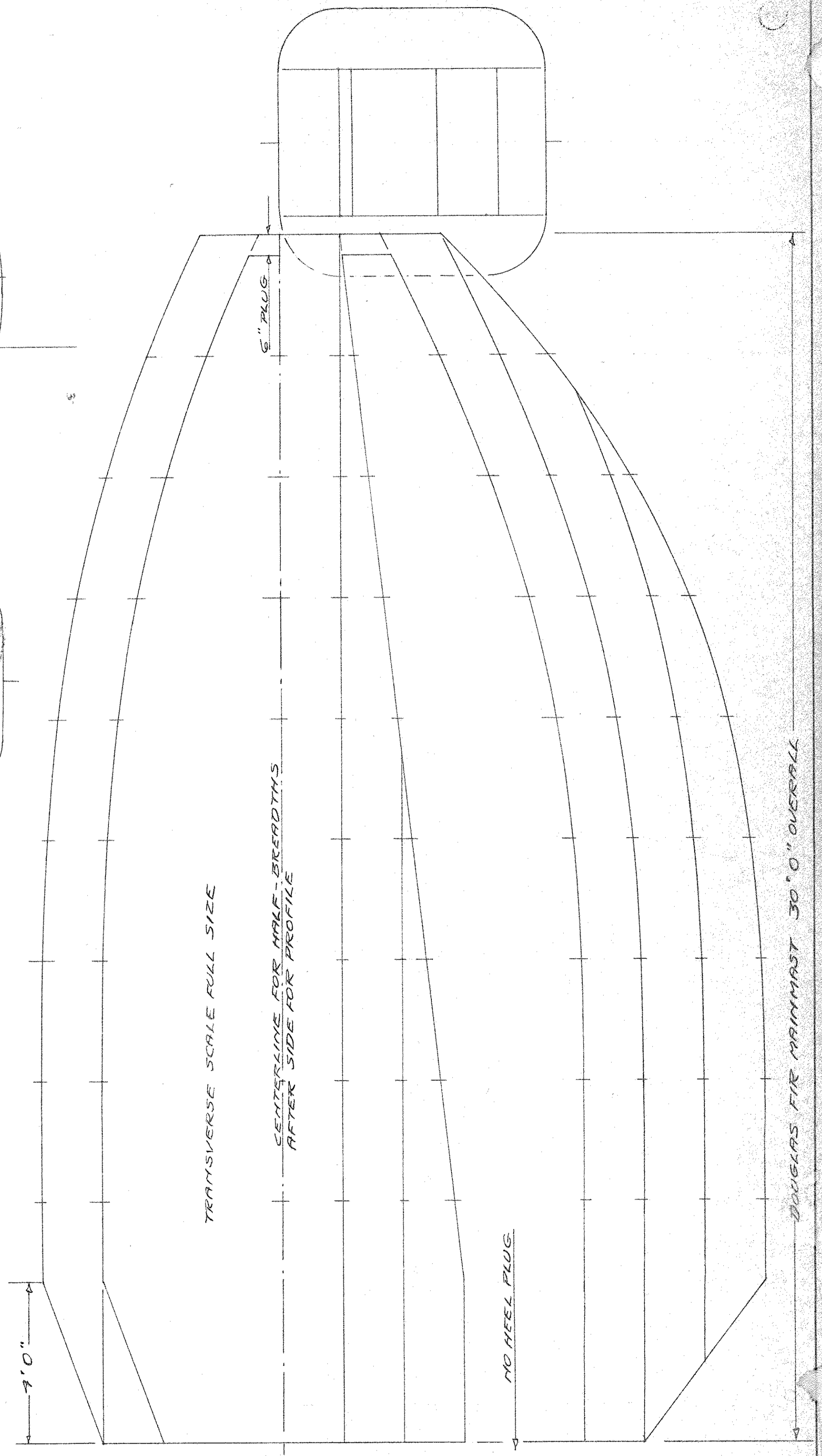
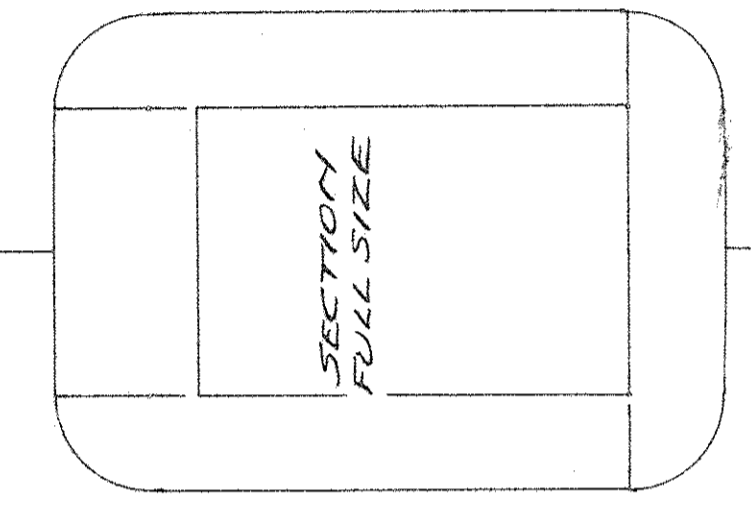
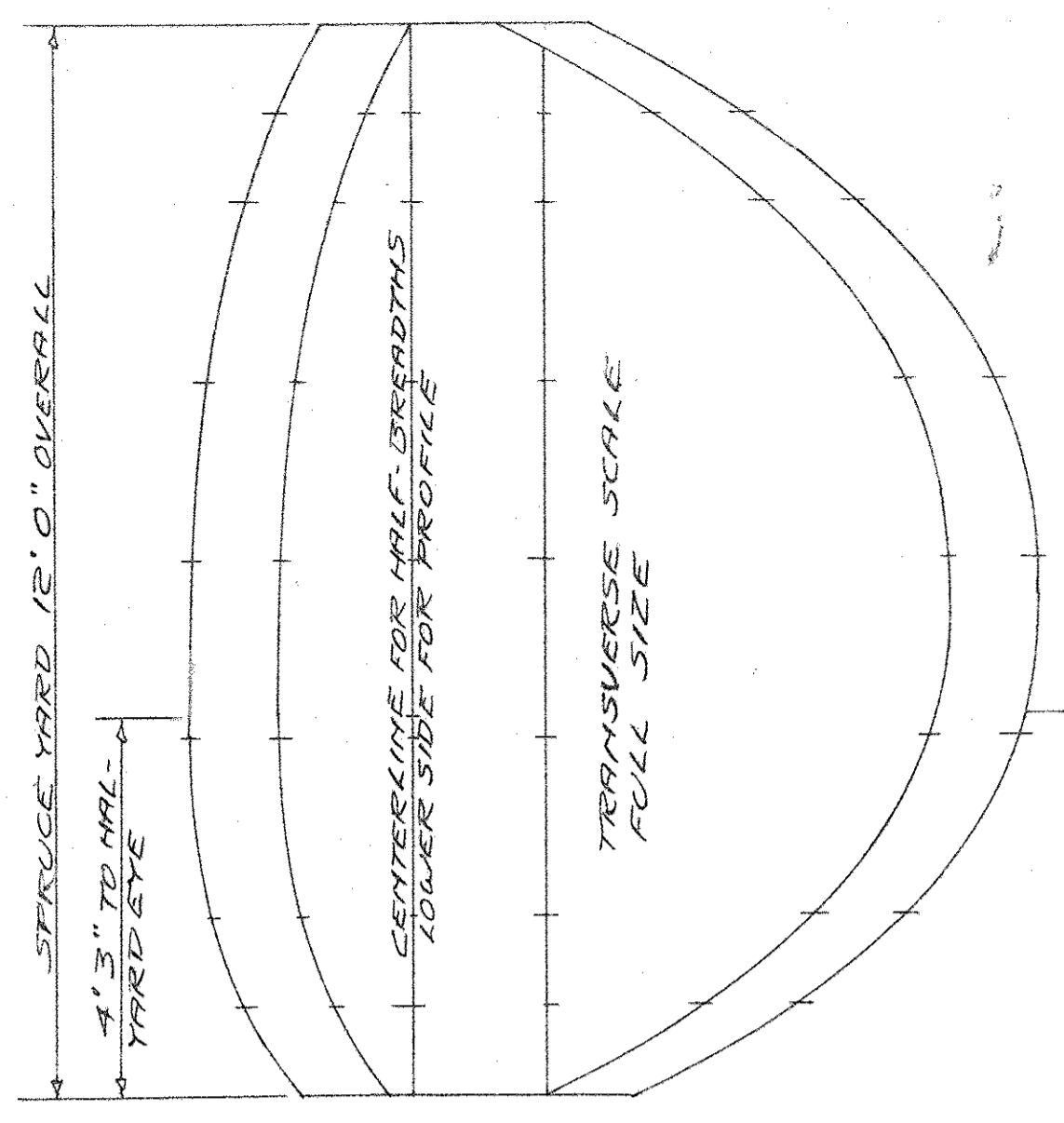
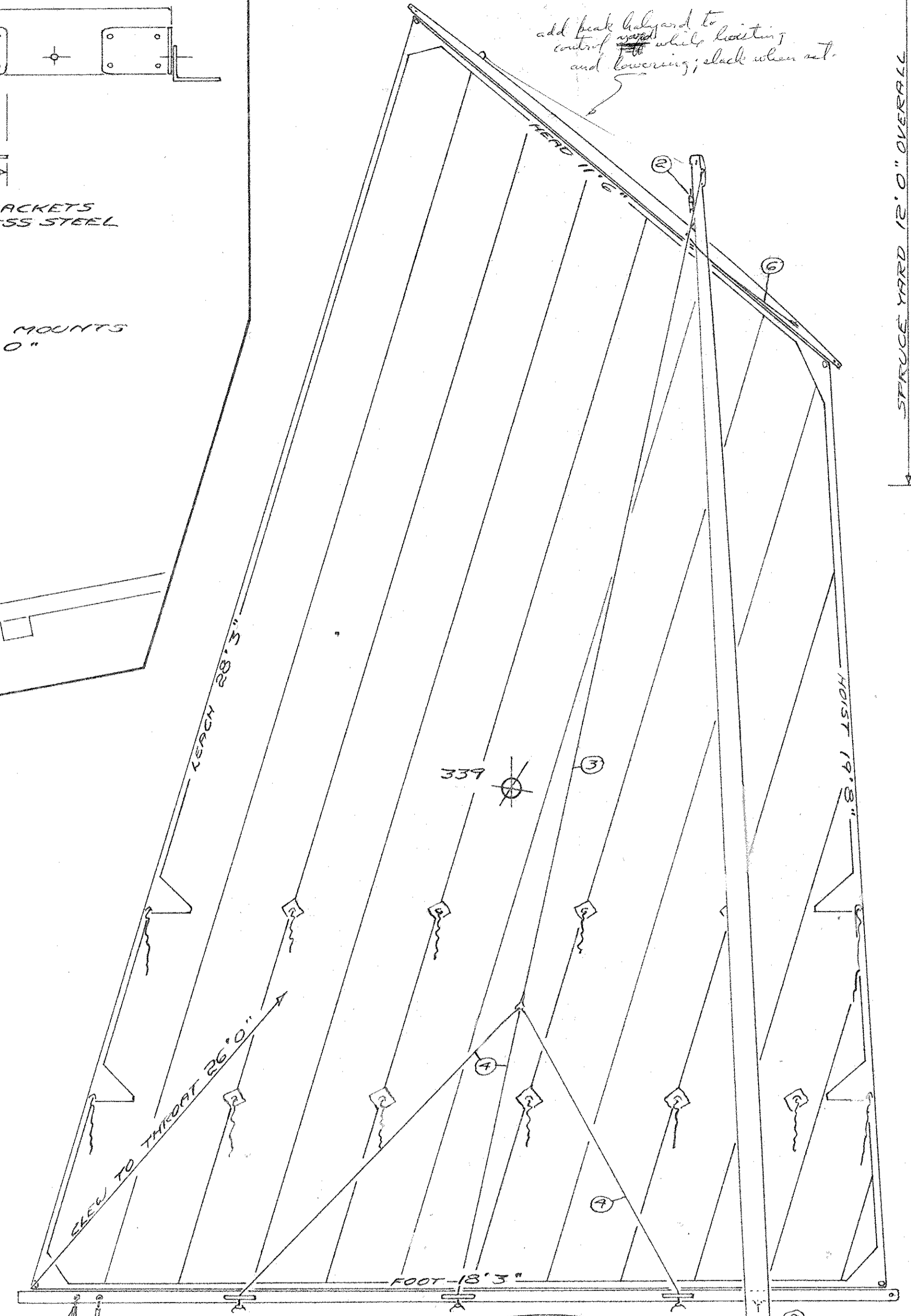

PART	DIAM.	STANDING END	FALL	BLOCKS NO.	SHEAVE	LOCATION	TYPE
① SHEET	1/2"	DECK BLOCK BECKET	DECK CLEAT	1	2 1/4"	STARB'D DECK	SWIVEL DECK PLATE WITH BECKET.
				1	"	BOOM BAIL	FRONT SHACKLE
				1	"	"	SIDE SHACKLE
② HALYARD	1/2"	YARD EYE	DECK CLEAT *	1	"	MASTHEAD EYE	SIDE SHACKLE ON A SLING.
③ LIFT	3/8"	ENDS ON LAZYJACKS PORT & STARB'D		1	1 3/4"	MASTHEAD	DUMB SHEAVE.
④ LAZYJACKS		ROVE THROUGH EYES ON LIFTS AND ADJUSTABLE UNDER BOOM					
⑤ DOWTHAUL	1/2"	EYE UNDER BOOM	CLEAT ON MAST.				
⑥ YARD PARREL	1/2"	SIDE OF YARD 4' 3"	SIDE OF YARD 1' 4" FROM HEEEL.				

*SEE DECK PLAN.

SCALE 1/2" = 1' 0"

DESIGN #429

3 1/2" x 6" x 1 1/2"

FOR VICTOR HOPWOOD

PHILIP C. BOLGER
DESIGNER
GLOUCESTER, MASSACHUSETTS